

EA2803QJ-T User's Guide

5V/2.4A Dual Cell Backup Battery Power Manager

Description

This document supports both the **EA2803QJ-T** and the **EA2803QJ-T0435** Evaluation Kits. These kits are a proven application-circuit design for the EA2803QJ-T and EA2803QJ-T0435 dual cell chargers with power path and single USB outputs. The EVKs contain a single micro-USB input and USB output. They provide output with 2.4A. They are configured to charge a 2S Lithium-ion battery with 1.0A. The EVKs operate with very high charge efficiency of 91% and discharge efficiency of 92%. EVKs are identical except for the IC. The ACT2803QJ-T EOC (end of charge voltage) is 4.2V while the EA2803QJ-T0435 EOC is 4.35V for each battery.

Features

The EVK contains a high efficiency Buck and Boost DC/DC converter that operates either in CV (Constant Voltage) mode or CC (Constant Current) mode. The EVK provides up to 2.4A output current at 400 KHz switching frequency. It operates from $V_{in}=4.5V$ to 5.5V and provides an output voltage of 5V. Gerber files are available to minimize time-to-market for applications that want to use the EVK as an end product.

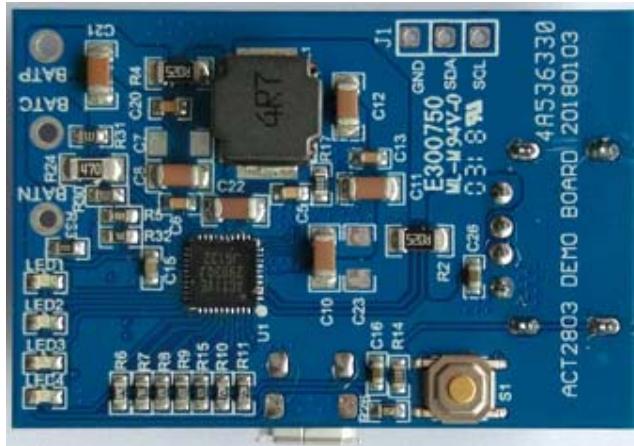

EVK Picture - Top

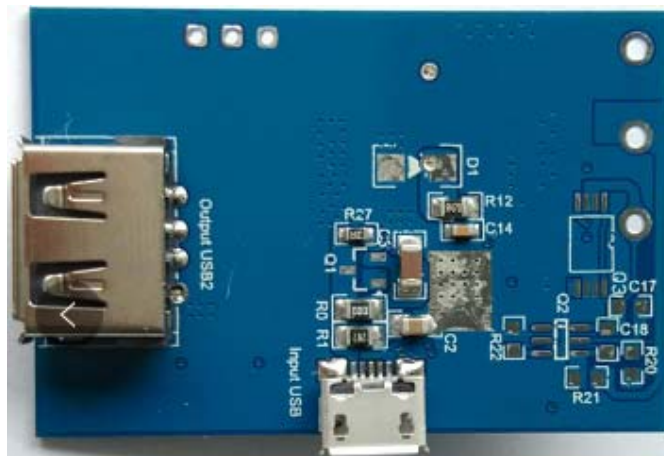

EVK Picture - Bottom

Setup

Required Equipment

EA2803QJ-T EVK

Power supply – 5V @ 2.4A for full power operation

Oscilloscope – >100MHz, >2 channels

Loads –Electronic/resistive load with 3.5A minimum current capability.

Digital Multimeters (DMM)

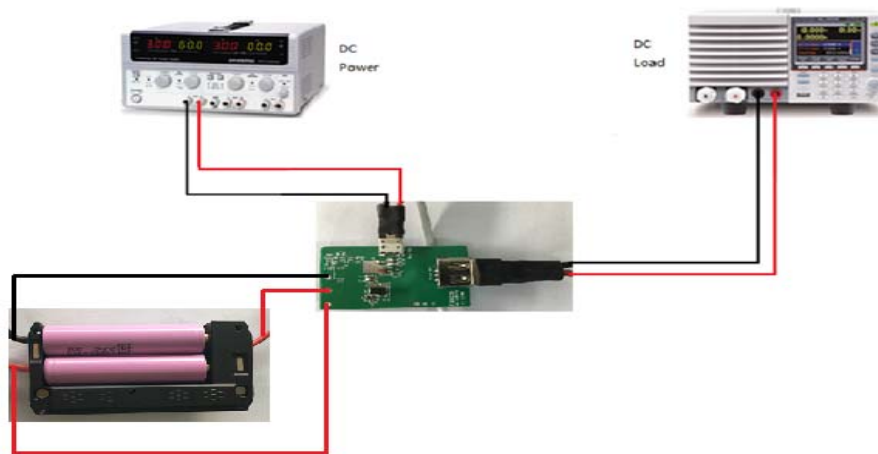

EVK Setup

Hardware Setup

1. Connect a DC power supply across Vin and GND on the EVK.
2. Connect the EVK output to electronic load by USB connector.
3. Connect the batteries at BATH and BATC as well as BATN pins.
4. Recommended Operating Conditions

Table 1. Recommended Operating Conditions

Parameter	Description	Min	Typ	Max	Unit
VIN	All buck input voltages	4.5	5	5.5	V
IOUT	Maximum load current		2.4		A

EVK Operation

Turn on

Apply 5V to input.

PCB Layout

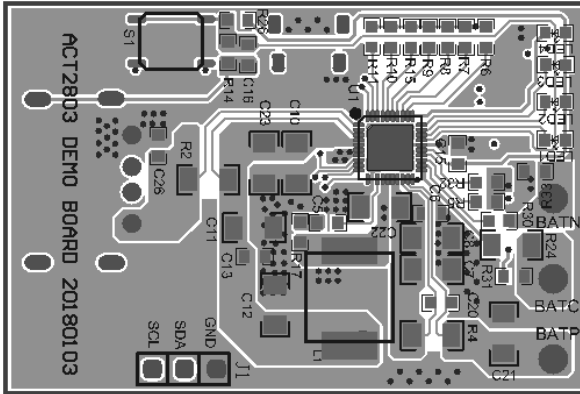

Top Layer

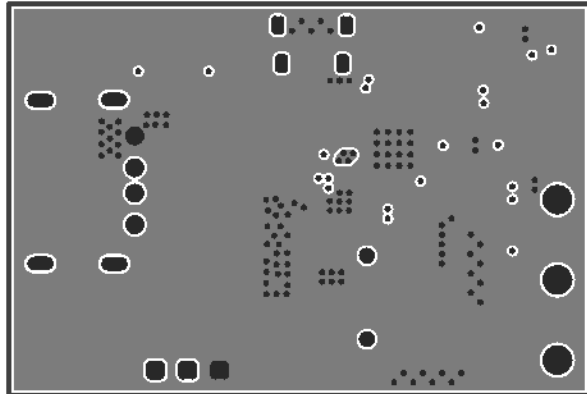

Middle 1 Layer

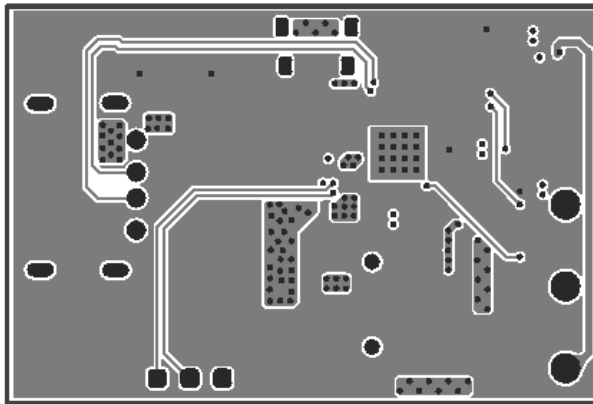

Middle 2 Layer

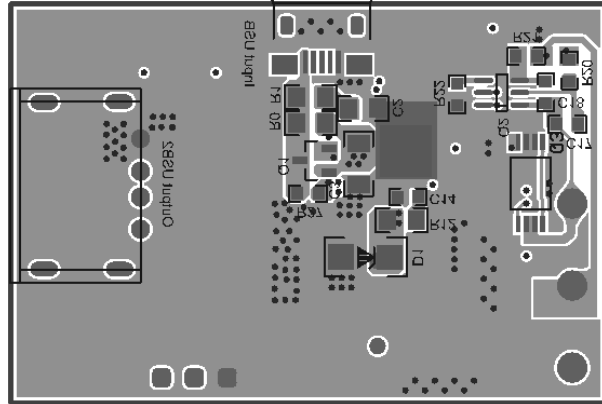

Bottom Layer

Test Results

Power Path Function

Input current(mA)	1499	1717	1931	2139	2227	2275	2329	2349	2412	2424	2421	2417	2408
Output current(mA)	0	200	400	600	800	1000	1200	1400	1600	1800	2000	2300	2380
Charge current(mA)	1019	1020	1018	1016	942	845	743	642	532	399	260	61	0

(Test condition: $V_{in}=5\text{ V}$, $V_{bat}=7.0\text{V}$, input current limit=2.75A, fast charge current=1.0A)

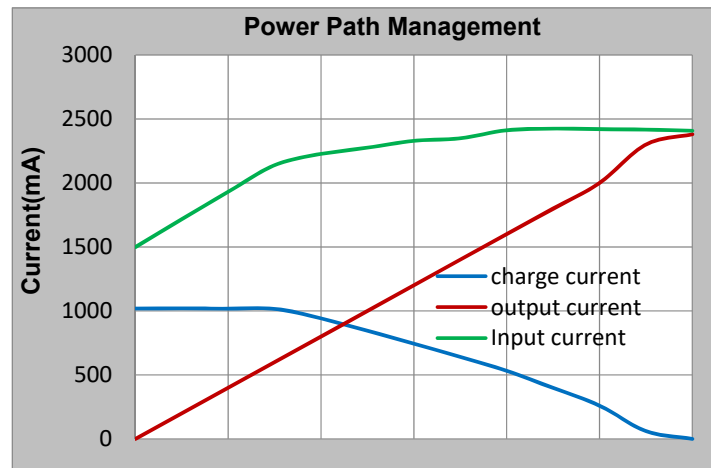

Charge Efficiency

($V_{in}=5\text{V}$ and charge current set at 1000mA)

Battery Voltage (V)	6.0	6.5	7.0	7.5	8.0	8.2
Efficiency (%)	95.9	95.3	94.1	93.1	92.1	91.7

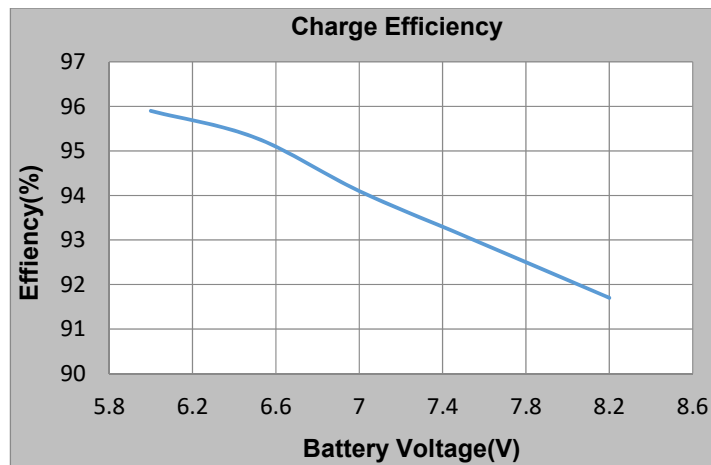

Buck Efficiency and Power Loss (Ta=25°C)

Vbat	Efficiency (%)				
	Io=500mA	Io=1000mA	Io=1500mA	Io=2000mA	Io=2400mA
6.0V	95.8	95.6	94.7	93.9	92.9
7.0V	93	94.6	94.1	93.2	92.5
8.4V	90.4	91.7	92	91.7	91.2

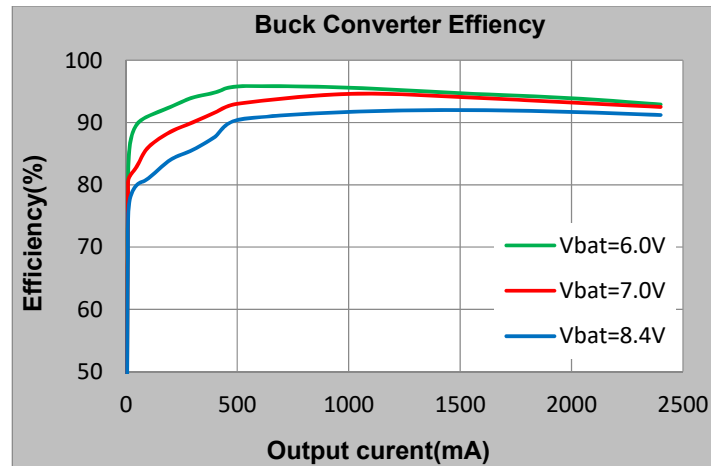

Vbat	Power Loss (W)				
	Io=500mA	Io=1000mA	Io=1500mA	Io=2000mA	Io=2400mA
6.0V	0.11	0.23	0.42	0.65	0.91
7.0V	0.19	0.29	0.47	0.73	0.98
8.4V	0.27	0.46	0.65	0.91	1.16

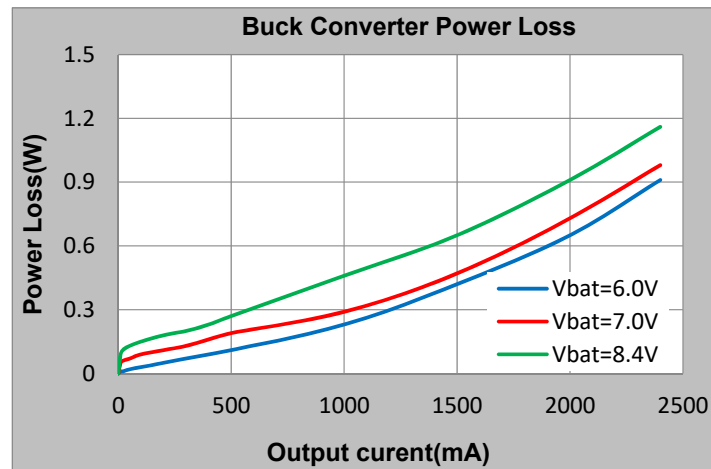

Buck Constant Current and Constant Voltage Regulation (Ta=25°C)

	Vbat=6.0V		Vbat=7.0V		Vbat=8.0V	
	Vout(V)	Iout(mA)	Vout (V)	Iout(mA)	Vout(V)	Iout(mA)
CC Load	5.23	0	5.23	0	5.23	0
	5.08	12	5.08	10	5.08	10
	5.02	1000	5.02	1000	5.01	1000
	4.99	1500	4.99	1500	4.98	1500
	4.96	2000	4.97	2000	4.96	2000
	4.94	2400	4.95	2400	4.94	2240
CV Load	4.92	2682	4.92	2692	4.92	2630
	4.9	2681	4.9	2687	4.9	2675
	4.8	2677	4.8	2685	4.8	2680
	4.6	2676	4.6	2683	4.6	2678
	4.4	2675	4.4	2681	4.4	2677
	4.2	2674	4.2	2679	4.2	2676
	4	2673	4	2677	4	2675
	3.9	2672	3.9	2676	3.9	2674
	3.8	2672	3.8	2675	3.8	2672
	3.7	2671	3.7	2674	3.7	2671
	3.6	2671	3.6	2674	3.6	2670
	3.5	2671	3.5	2673	3.5	2668
3.4	0	3.4	0	3.4	0	

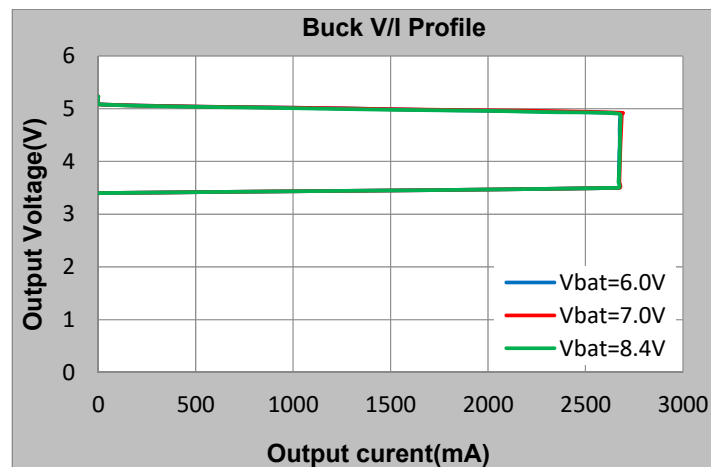

Battery Leakage Current in HZ Mode

Test Conditions	Battery Input Current (μA)	Power Loss (μW)
Vbat=6V	2.5	15
Vbat=7V	2.6	18.2
Vbat=8V	2.8	22.4
Vbat=8.4V	3.1	26

Ripple and Noise

Ripple & noise are measured by using 20MHz bandwidth limited oscilloscope.

Output Ripple at 2.4A Load	Vbat=6.0V	Vbat=7.0V	Vbat=8.4V
Ripple(mV)	45	40	40

Load Dynamic Response Load Step

CH2:VOUT, CH4:IOUT

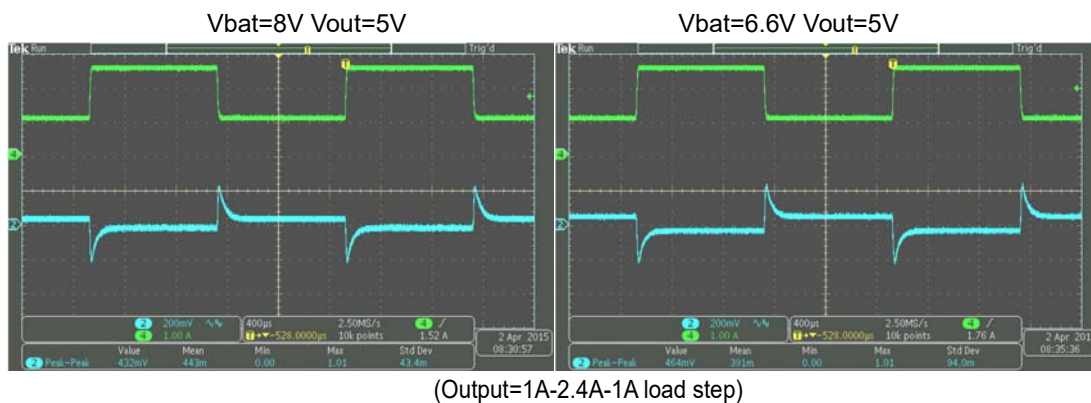
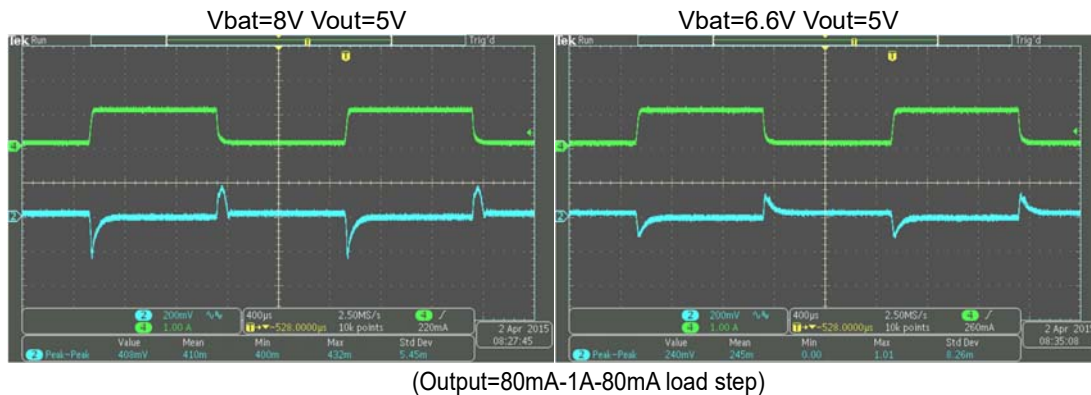

LED Indication

Conventional LED indication

PB time>40ms (HZ Mode)	LED1	LED2	LED3	LED4
$V_{BAT} < V_{cut-off}$	Off	Off	Off	Off
$V_{cut-off} \leq V_{BAT} < V_{LED1}$	Flash	Off	Off	Off
$V_{LED1} \leq V_{BAT} < V_{LED2}$	On	Off	Off	Off
$V_{LED2} \leq V_{BAT} < V_{LED3}$	On	On	Off	Off
$V_{LED3} \leq V_{BAT} < V_{LED4}$	On	On	On	Off
$V_{BAT} \geq V_{LED4}$	On	On	On	On

Charge Mode	LED1	LED2	LED3	LED4
$V_{BAT} < V_{LED1}$	Flash	Off	Off	Off
$V_{LED1} \leq V_{BAT} < V_{LED2}$	Flash	Off	Off	Off
$V_{LED2} \leq V_{BAT} < V_{LED3}$	On	Flash	Off	Off
$V_{LED3} \leq V_{BAT} \leq V_{LED4}$	On	On	Flash	Off
$V_{LED4} \leq V_{BAT} \leq \text{EOC Mode}$	On	On	On	Flash
$LED4 \leq V_{BAT} (\text{EOC Mode})$	On	On	On	On

ACT2803 is designed with a simple ADC to convert 5 levels of PT pin voltage into 5 application patterns.

INDICATION PATTERN	PT Resistor
Conventional	R15=3.3K
Always On In Discharge	
Conventional	R15=12K
5s Indication in Discharge	
Breathing	R15=24K
5s Indication in Discharge	
Bottom Charging	R15=42K
5s Indication in Discharge	
Circulating	R15=68K
5s Indication in Discharge	

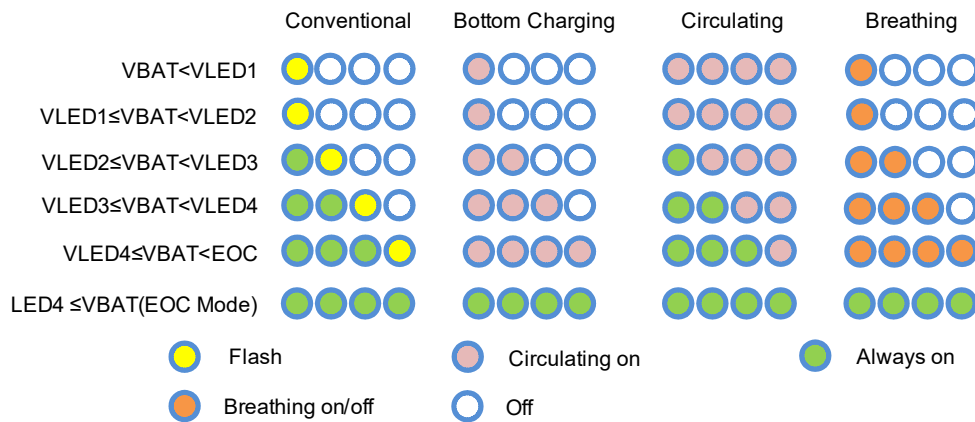

System Management

- PB is pressed for >5s or Discharge load is <10mA for 12.5s, Discharge mode is go into HZ mode
- PB is pressed for 40ms, Discharge mode is turned on
- PB is pressed for 40ms, LED indication is on for 5.0 seconds
- 2 seconds transition time between Charge Mode and Boost Mode

Key Components Temperature Test (Ta=25C, burning for 2 hours)

Charge mode, 1.0A charge current

Vin(V)	IC(°C)	Inductor(°C)	Vbat(V)
5	36.5	34.3	6
5	45.4	41.8	7.5
5	51.6	46.6	8.2

Discharge mode, 2.4A output current

Vbat(V)	IC(°C)	Inductor(°C)	Vout(V)
6	49	43.2	5
7	50.3	44.2	5
8	52.5	46.2	5
8.4	53.1	46.9	5

EMI Test

Vbat=7.8V, Output: 5V/2.4A Horizontal

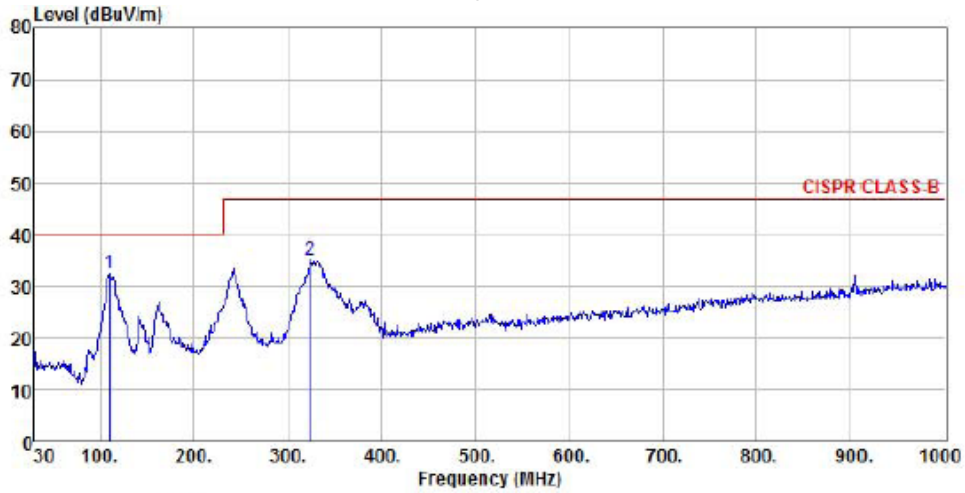

Site : chamber
 Condition : CISPR CLASS-B 3m VULB9160 HORIZONTAL
 EUT :
 Model Name : ACT2803
 Temp/Humi : 21 °C / 50 %
 Power Rating:
 Mode : 5V/2.4A
 Memo :

	ReadAntenna	Cable Preamp	Limit	Over					
	Freq	Level	Factor	Loss	Factor	Level	Line	Limit	Remark
	MHz	dBuV	dB/m	dB	dB	dBuV/m	dBuV/m	dB	
1 pp	109.54	20.11	11.07	1.41	0.00	32.59	40.00	-7.41	Peak
2	323.91	18.84	13.74	2.51	0.00	35.09	47.00	-11.91	Peak

Vbat=7.8V, Output: 5V/2.4A Vertical

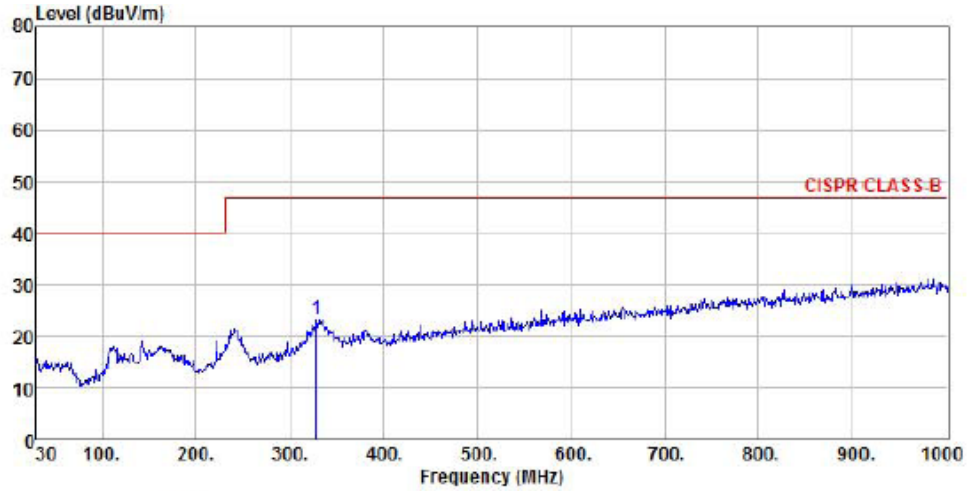

Site : chamber
 Condition : CISPR CLASS-B 3m VULB9160 VERTICAL
 EUT :
 Model Name : ACT2803
 Temp/Humi : 21 °C / 50 %
 Power Rating:
 Mode : 5V/2.4A
 Memo :

	ReadAntenna	Cable	Preamp	Limit	Over		
Freq	Level	Factor	Loss	Factor	Level	Line	
MHz	dBuV	dB/m	dB	dB	dBuV/m	dBuV/m	
1 pp 328.76	7.09	13.87	2.48	0.00	23.44	47.00	-23.56 Peak

Schematic

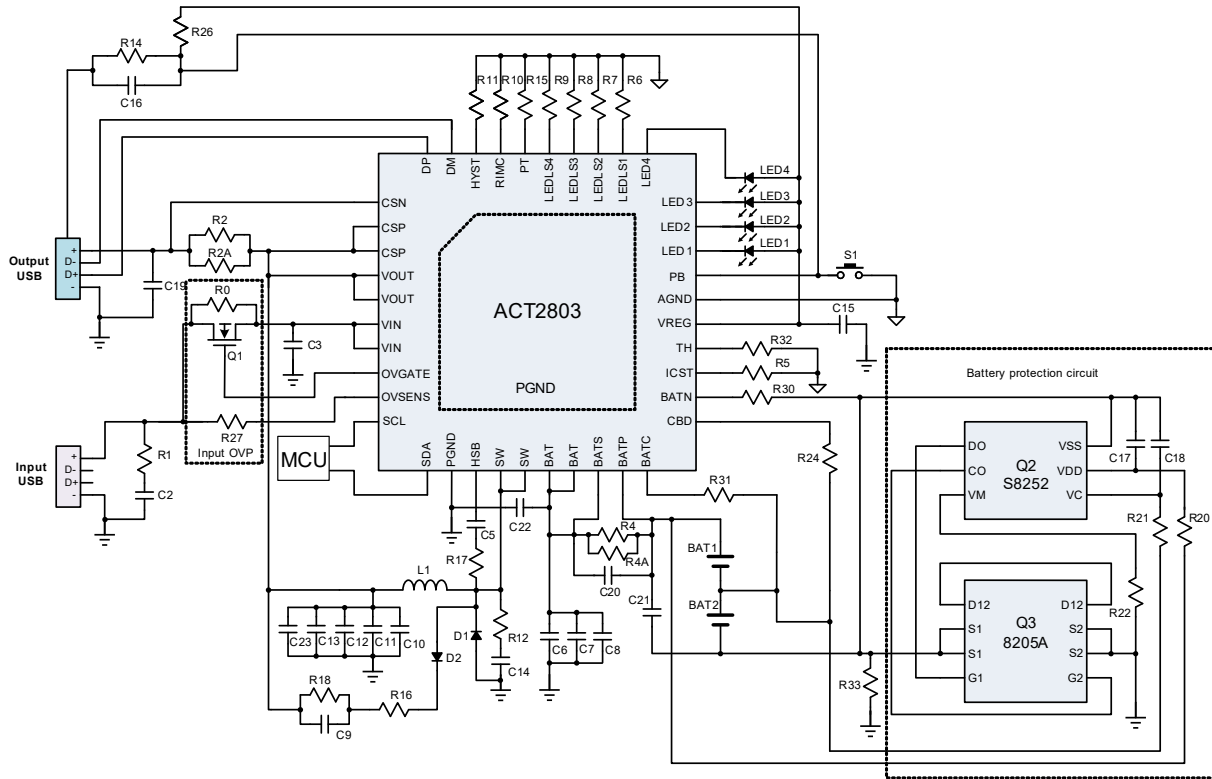

Bill of Materials

Item	Designator	Description	QTY		MFR
			EA2803QJ-T	EA2803QJ-T0435	
1	L1	SWPA8040S4R7NT 4.7uH 5.9A	1	1	Sunlord
2	D1	MBR1020VL, 20V/1A Schottky	0	0	Panjit
3	D2	MBR1020VL, 20V/1A Schottky	0	0	Panjit
4	C2	Ceramic capacitor, 4.7uF/10V, X7R, 0805	1	1	Murata/TDK
5	C3,C8,C10, C11,C12, C21,C22	Ceramic capacitor, 22uF/10V, X7R, 1206	7	7	Murata/TDK
6	C5	Ceramic capacitor, 47nF/16V, X7R, 0603	1	1	Murata/TDK
7	C6,C13,C20	Ceramic capacitor, 0.1uF/16V, X7R, 0603	3	3	Murata/TDK
8	C7,C23	Ceramic capacitor, 22uF/10V, X7R, 1206	0	0	Murata/TDK
9	C9	Ceramic capacitor, 47nF/16V, X7R, 0603	0	0	Murata/TDK
10	C14	Ceramic capacitor, 2.2nF/10V, X7R, 0603	1		Murata/TDK
11	C15	Ceramic capacitor, 1uF/10V, X7R, 0603	1	1	Murata/TDK
12	C16	Ceramic capacitor, 2.2uF/10V, X7R, 0603	1	1	Murata/TDK
13	C17,C18	Ceramic capacitor, 0.22uF/10V, X7R, 0603	0	0	Murata/TDK
14	C26	Ceramic capacitor, 3.3uF/10V, X7R, 0603	0	0	Murata/TDK
15	R0	Chip Resistor, 0Ω, 1/8W, 5%, 0805	1	1	Murata/TDK
16	R1	Chip Resistor, 2.7Ω, 1/8W, 5%, 0805	1	1	Murata/TDK
17	R2,R2A, R4,R4A	Chip Resistor, 50mΩ, 1/4W, 1%, 1206	4	4	Sart
18	R5	Chip Resistor, 8kΩ, 1/10W, 1%, 0603	1	1	Murata/TDK
19	R6	Chip Resistor, 83kΩ, 1/10W, 1%, 0603	1	1	Murata/TDK
20	R7	Chip Resistor, 63.5kΩ, 1/10W, 1%, 0603	1	1	Murata/TDK
21	R8	Chip Resistor, 51.4kΩ, 1/10W, 1%, 0603	1	1	Murata/TDK
22	R9	Chip Resistor, 41.5kΩ, 1/10W, 1%, 0603	1	1	Murata/TDK
23	R10,R11	Chip Resistor, 540kΩ, 1/10W, 1%, 0603	1	1	Murata/TDK
24	R12	Chip Resistor, 0.47Ω, 1/8W, 1%, 0805	1	1	Murata/TDK
25	R14,R26	Chip Resistor, 715K, 1/10W, 5%, 0603	2	2	Murata/TDK
26	R15	Chip Resistor, 12K, 1/10W, 1%, 0603	1	1	Murata/TDK
27	R16	Chip Resistor, 4.7Ω, 1/8W, 1%, 0805	0	0	Murata/TDK
28	R17	Chip Resistor, 10Ω, 1/10W, 5%, 0603	1	1	Murata/TDK

29	R18	Chip Resistor, 47Ω, 1/8W, 5%, 0805	0	0	Murata/TDK
30	R20,R21	Chip Resistor, 510Ω, 1/10W, 5%, 0603	0	0	Murata/TDK
31	R22	Chip Resistor, 1K, 1/10W, 5%, 0603	0	0	Murata/TDK
32	R24	Chip Resistor, 47Ω, 1/4W, 1%, 1206	1	1	Murata/TDK
33	R27	Chip Resistor, 100Ω, 1/10W, 1%, 0603	1	1	Murata/TDK
34	R30,R31	Chip Resistor, 510Ω, 1/10W, 5%, 0603	2	2	Murata/TDK
35	R32	Chip Resistor, 10K, 1/10W, 5%, 0603	1	1	Murata/TDK
36	R33	Chip Resistor, 10K, 1/10W, 5%, 0603	1	1	Murata/TDK
37	LED1,LED2, LED3,LED4	LED, Blue	4	4	LED Manu
38	Q1	20V/6.5A N MOSFET, Optional	0	0	Silikron
39	Q2	2S Battery protection IC	0	0	Seiko
40	Q3	20V Dual N-Channel Power MOSFET	0	0	Fortune
41	PB	Push Button Switch	1	1	
42	Output USB	4P	1	1	
43	Micro-USB	MICRO USB 5P/F	1	1	
44	U1	IC, ACT2803QJ-T, QFN55-40	1	0	Active Semi
		IC, ACT2803QJ-T0435, QFN55-40	0	1	